

# Topics on Modulations for 5G and Beyond

---

**Xiang-Gen Xia**

University of Delaware, Newark, DE, USA

[xxia@ee.udel.edu](mailto:xxia@ee.udel.edu); [xianggen@gmail.com](mailto:xianggen@gmail.com)

URL: <http://www.ee.udel.edu/~xxia>

---

# Outline

- Review of the past standards
  - Some comments
  - Some 5G topics: GFDM, FBMC, massive MIMO, SCMA
  - Vector OFDM
  - Conclusion
-

# Communications

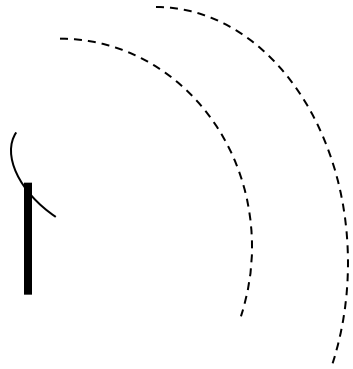

wireless

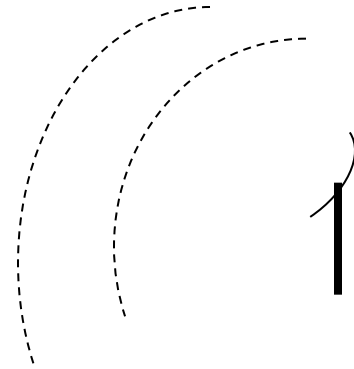

transmission through EM wave propagation

wired

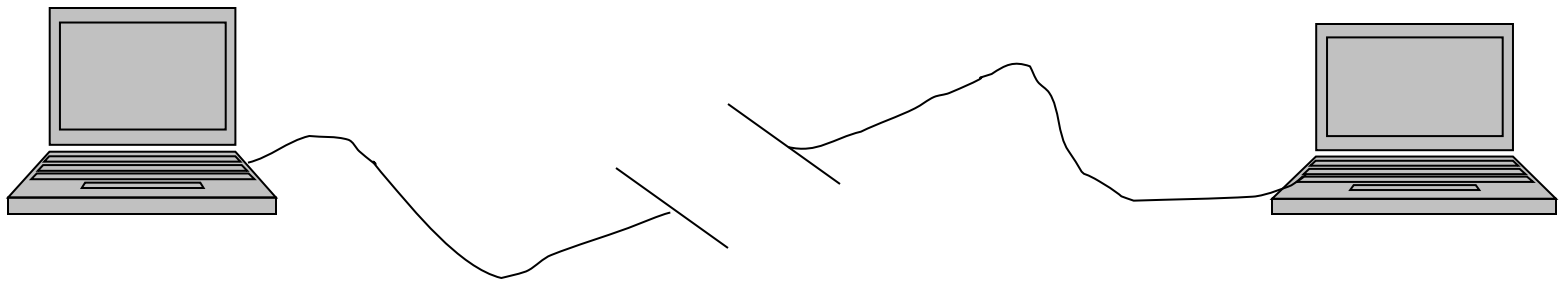

# Signal:

$A(t) \cos(p(t))$  carry information

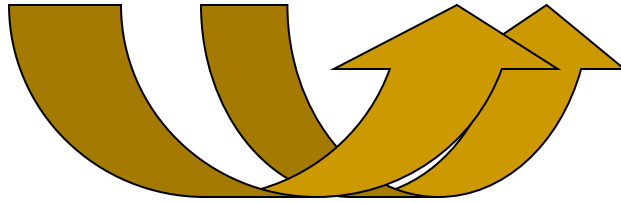

# Channel:

a media that wave carrying information propagates through

→ Approximately a linear system

system frequency response

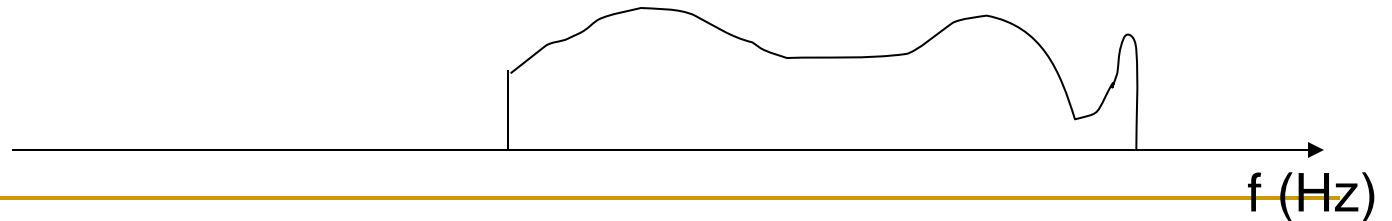

signal  
 $\cos(p(t))$

channel

System/channel frequency response

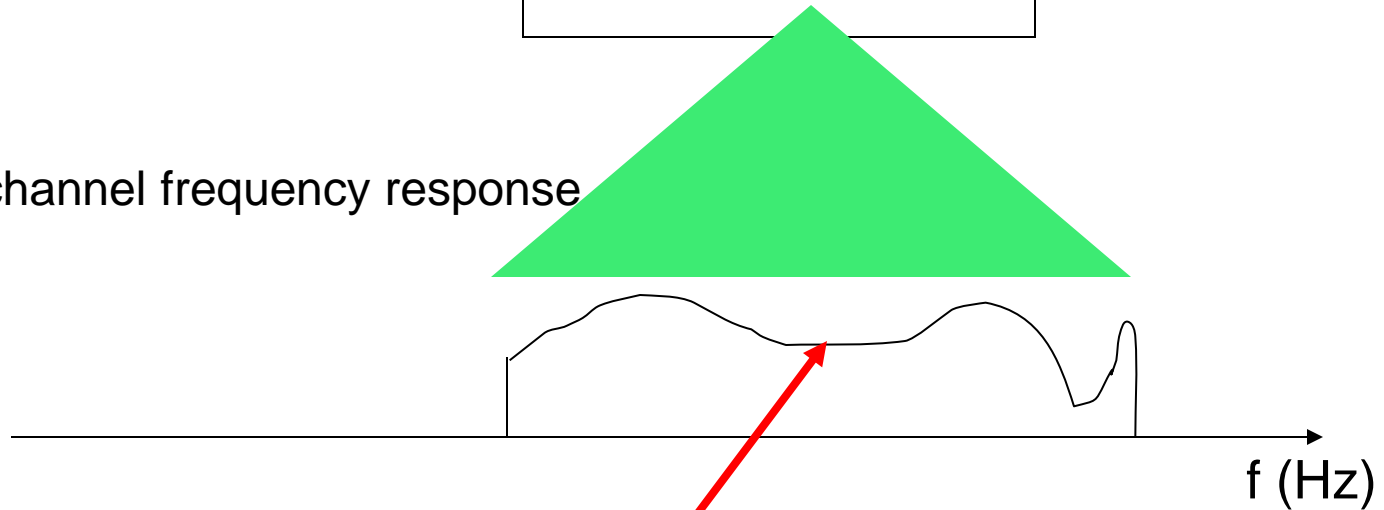

(approximately) flat

none flat

additive white Gaussian (AWGN)

intersymbol interference (ISI)

# In broadband systems

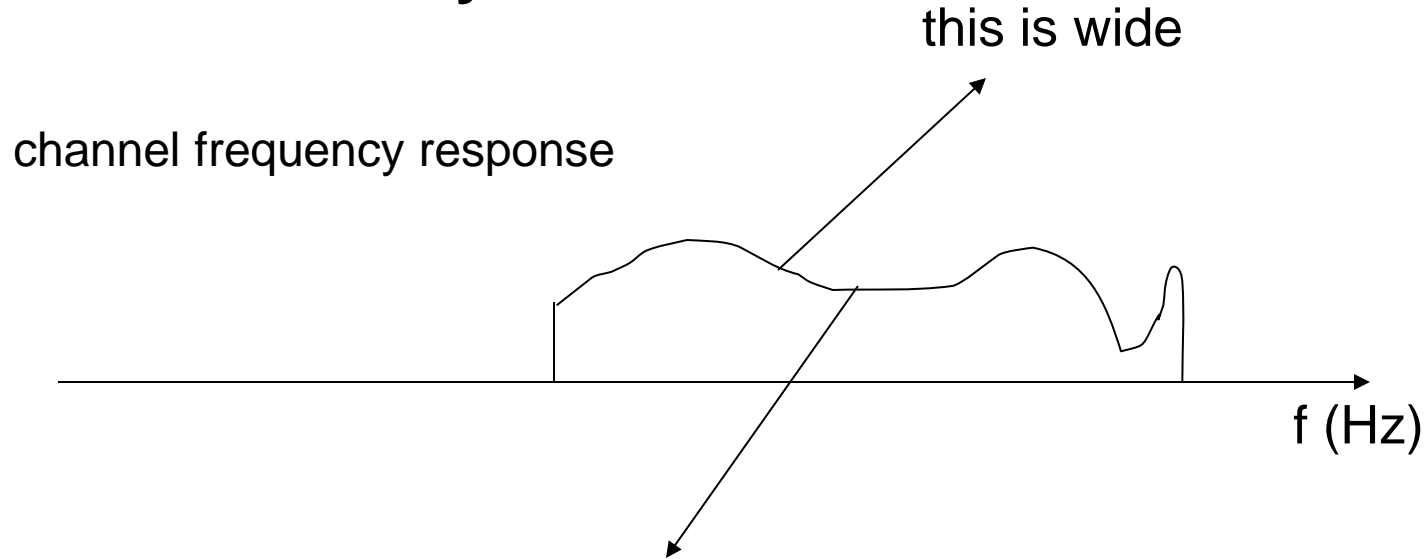

It is not possible to be flat → ISI occurs

Wireless: Multipath

Wired: None flat ISI channel  
None ideal

# Wired (modem): Channel is fixed and has high SNR

< 9.6 kbs/s

equalization (Lucky 60s)

9.6 kbs/s

TCM +equalization (DFE)

Squeeze more bits  
to a symbol

14.4 kbs/s

28.8 kbs/s

56 kbs/s

TCM + equalization

Asymmetric Digital Subscriber Line (**ADSL**)

**6 Mbs/s**

**orthogonal frequency division  
multiplexing (OFDM)**

**or called discrete multi-tone (DMT)**

Use more  
bandwidth

Data Rate	Wire Size	Distance
1.5 or 2 Mbps	0.5 mm	5.5 Km
1.5 or 2 Mbps	0.4 mm	4.6 Km
6.1 Mbps	0.5 mm	3.7 Km
6.1 Mbps	0.4 mm	2.7 Km

**The physical layer  
was mainly  
on dealing with ISI**

# Wireless Systems: Channel varies/fades and not high SNR

outdoor

indoor

multipaths

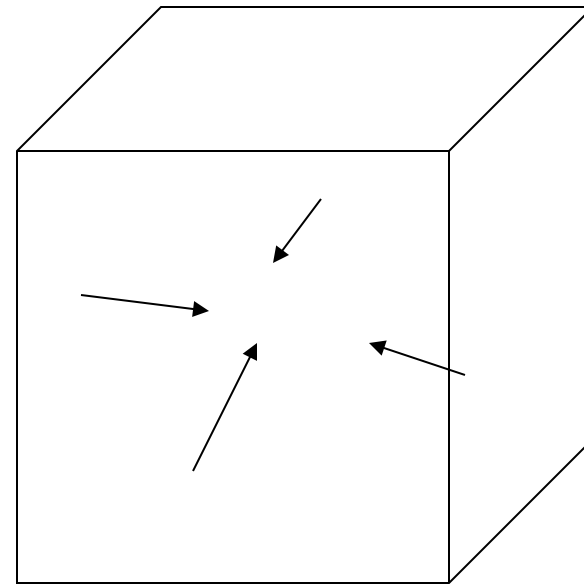
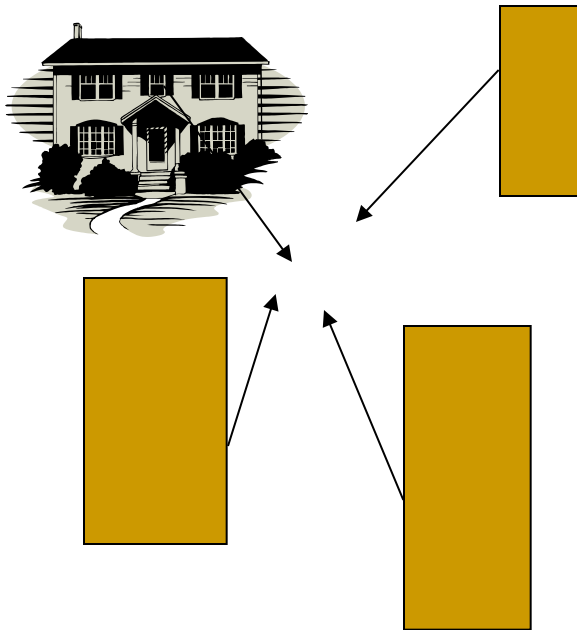

multiple reflections



# Multipath

narrowband case

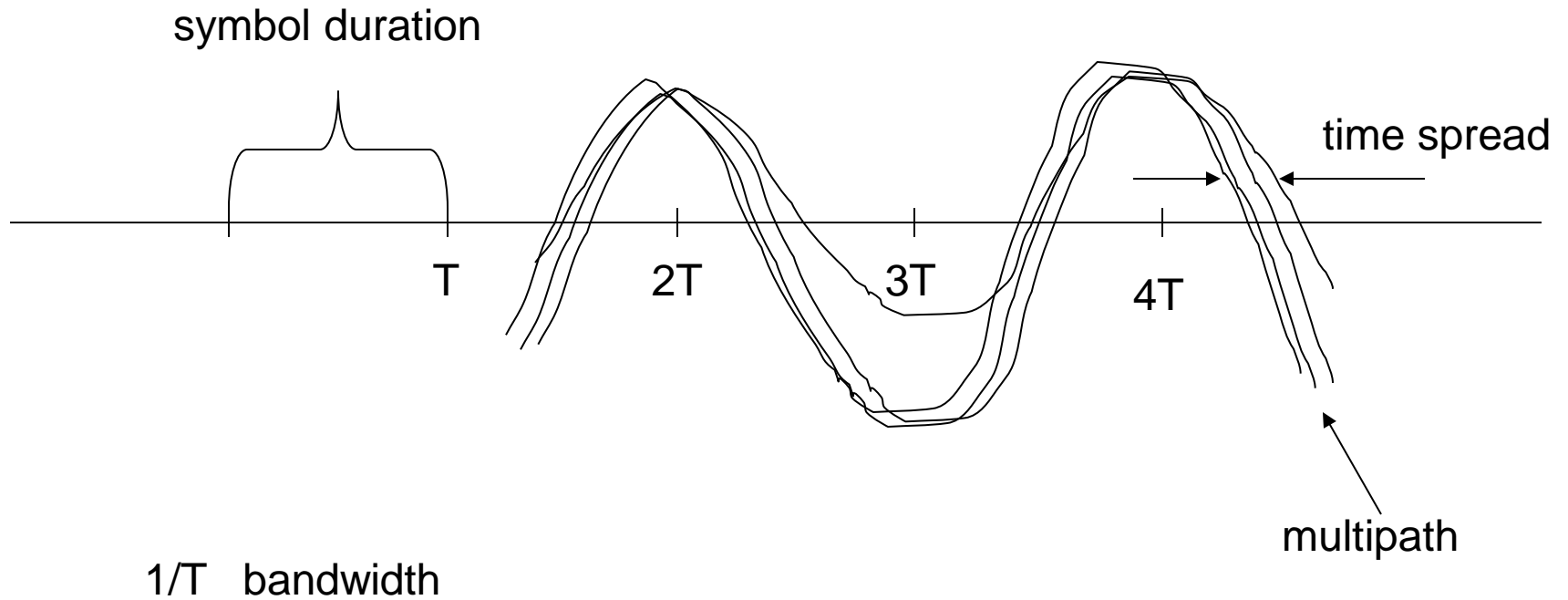

No intersymbol interferences

When the bandwidth is too wide or  $T$  is too small, the time spread may be across over multiple symbols. In this case, intersymbol interference (ISI) occurs.

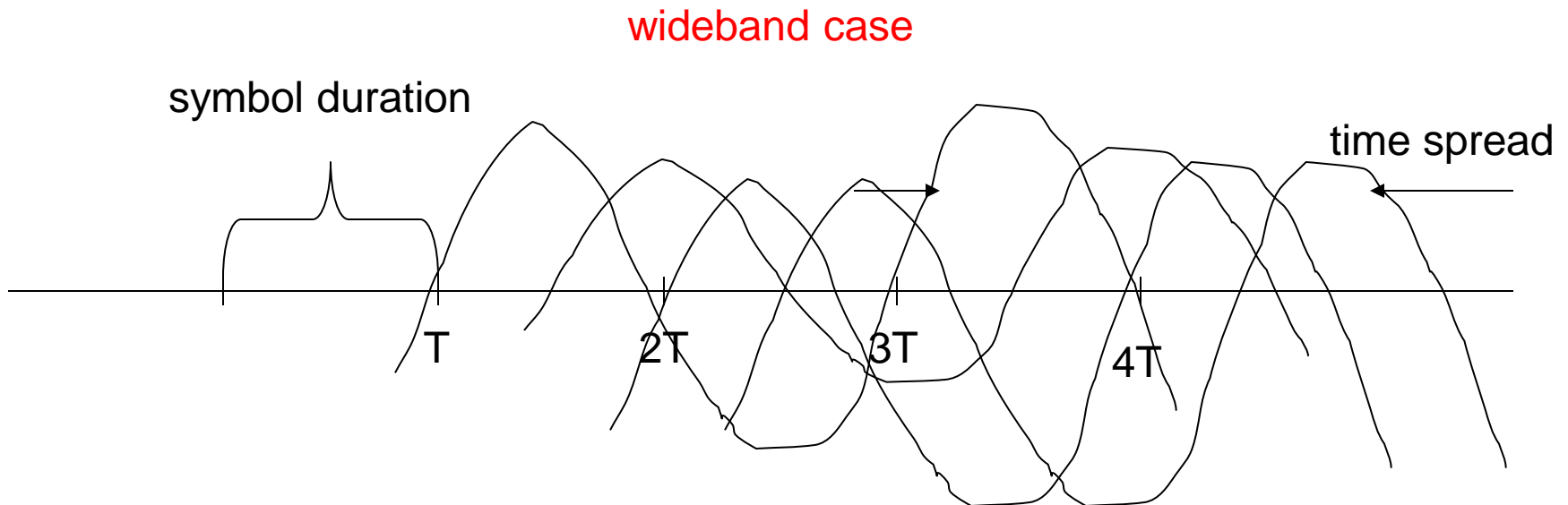

$x(t)$ : transmitted signal;  $r(t)$ : received signal

$$r(t) = \sum_{n=0}^L h(n)x(t - nT) + W(t)$$

ISI

AWGN

# Number of Multipath vs. Modulation Methods in Wireless Applications

2G (IS-95)	1.23 MHz	Almost optimal for single path (or equivalent)
3G (WCDMA CDMA2000)	< 11 MHz	6--8 multipaths (or equivalent) almost the break point to use CDMA
IEEE 802.11b (LAN)	similar to 3G	
IEEE 802.11a (LAN)	20 MHz	16 multipaths (or equivalent) OFDM
IEEE 802.11n (LAN)	20 & 40MHz	40MHz doubles everything in 20MHz OFDM
4G LTE	20 MHz	16 multipaths (or equivalent) OFDM and SC-FDE
5G	100 MHz or more	what <b>basic</b> modulation schemes??

## Digital Wireless Standards vs. Bandwidth (#of Multipaths)

- A standard is determined by a bandwidth (so far)
- 2G: 1.23MHz, almost the highest for non-ISI (or highest for TDMA in cellular systems)
  - Both TDMA and CDMA (DS spread spectrum) work well
- 3G: ~10 MHz, a few multipaths, highest for CDMA
  - Due to the ISI and wireless varying channels, time domain equalization may not work well, TDMA is not used, but CDMA (DS spread spectrum) is used in all standards since it is good to resist a few chip level time delays (RAKE receiver)
- 4G: 20 MHz, more multipaths
  - **Even CDMA RAKE receiver may not work well**
  - **OFDM is adopted (down link)**
    - Due to wireless channel varying, the number of subcarriers,  $N=64$ , is used, 25% data overhead for the cyclic prefix (CP) to deal with the multipaths

# Some Comments on These Standards

- The modulation schemes for all these standards are determined by the way to deal with ISI.
  - In my opinion, multi-access or multi-cells is **NOT** the problem to determine which basic modulation is used
  - Adding more antennas or not is the hardware choice and may not determine a basic modulation (?)
  - A basic modulation has to be simple
- Dealing with ISI is the key

## **Some Recent 5G Topics:**

**GFDM(DGT/IDGT), OQAM-OFDM, FBMC,  
Massive MIMO, SCMA**

# Generalized Frequency Division Multiplexing for 5th Generation Cellular Networks

Nicola Michailow, Maximilian Matthé, Ivan Simões Gaspar, Ainoa Navarro Caldevilla,  
Luciano Leonel Mendes, Andreas Festag, *Senior Member, IEEE*, and Gerhard Fettweis, *Fellow, IEEE*

*(Invited Paper)*

**Abstract**—Cellular systems of the fourth generation (4G) have been optimized to provide high data rates and reliable coverage to mobile users. Cellular systems of the next generation will face more diverse application requirements: the demand for higher data rates exceeds 4G capabilities; battery-driven communication sensors need ultra-low power consumption; and control applications require very short response times. We envision a unified physical layer waveform, referred to as generalized frequency division multiplexing (GFDM), to address these requirements. In this paper, we analyze the main characteristics of the proposed waveform and highlight relevant features. After introducing the principles of GFDM, this paper contributes to the following areas: 1) the means for engineering the waveform’s spectral properties; 2) analytical analysis of symbol error performance over different channel models; 3) concepts for MIMO-GFDM to achieve diversity; 4) preamble-based synchronization that preserves the excellent spectral properties of the waveform; 5) bit error rate

and Quality of Service (QoS). It also introduced Multimedia Message Service, which revolutionized the way people communicate. The third generation enabled mobile Internet and data rates not too far behind of wired solutions of the time. The advent of smartphones with large storage and processing capabilities equipped with high definition screen and cameras in combination with social networks that turned mobile media consumers into content providers, has pushed the fourth generation towards even higher throughput. Starting with the second generation, the evolution of the mobile communication systems has focused on increasing the throughput.

However, the scenarios foreseen for future fifth generation (5G) networks have requirements that clearly go beyond current data rates [1], [2]. The main scenarios for 5G networks

# DGT: Analysis GFDM: Receiver (Short-Time Fourier Transform)

Fourier Transform

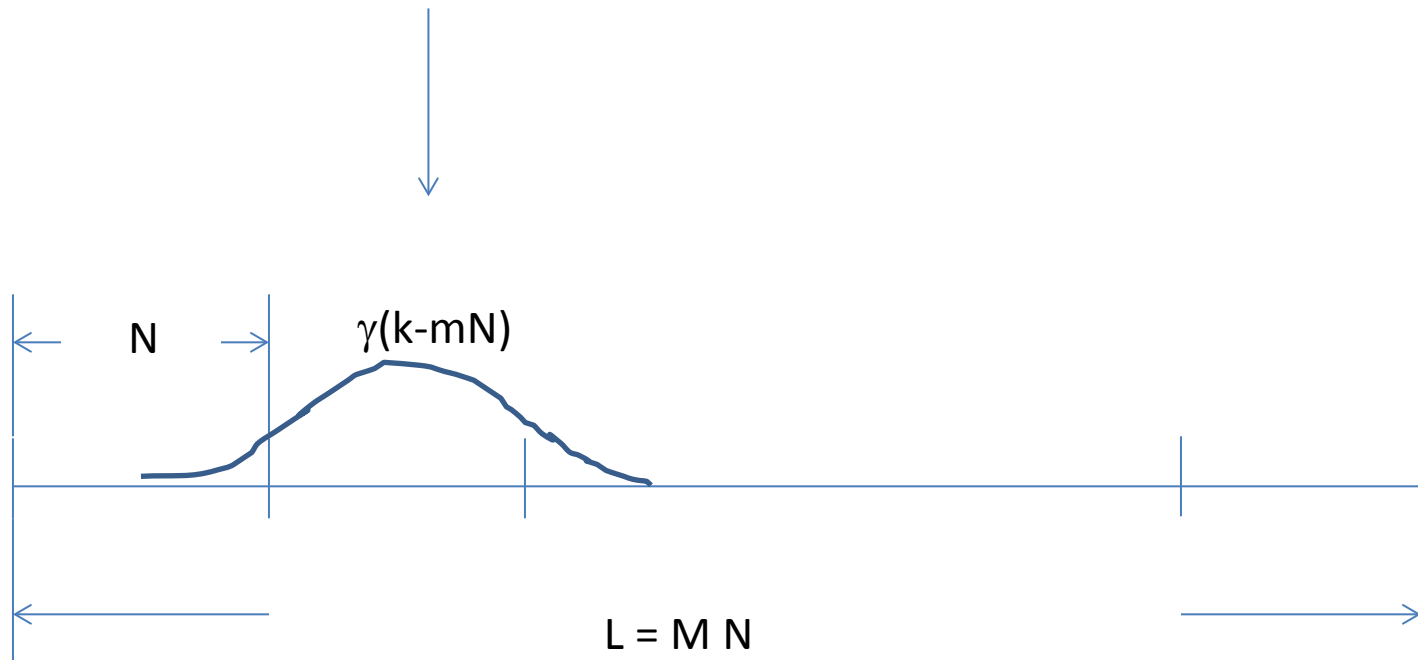



# Why Short Time Fourier Transform ?

- A signal in an observation time window may have time-varying frequencies, such as

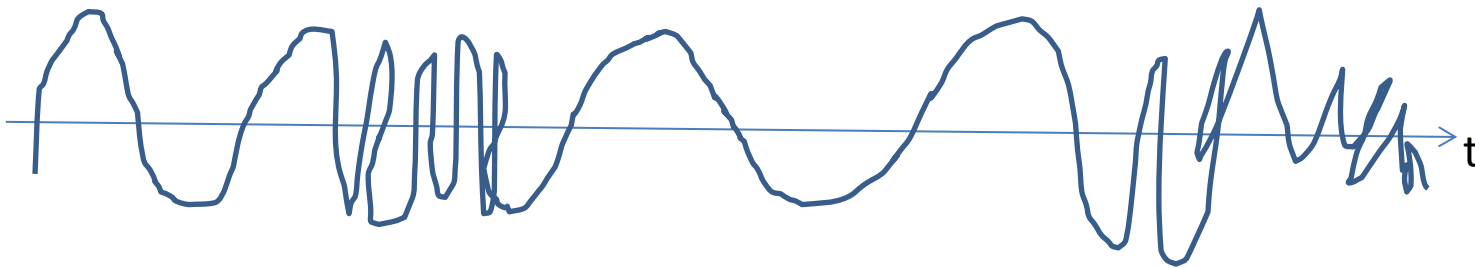

- If you take the Fourier transform to the whole signal, it does not tell when the frequency changes.



- The question is how to find out not only the frequency components but also when the frequency changes.

# Joint Time-Frequency Analysis

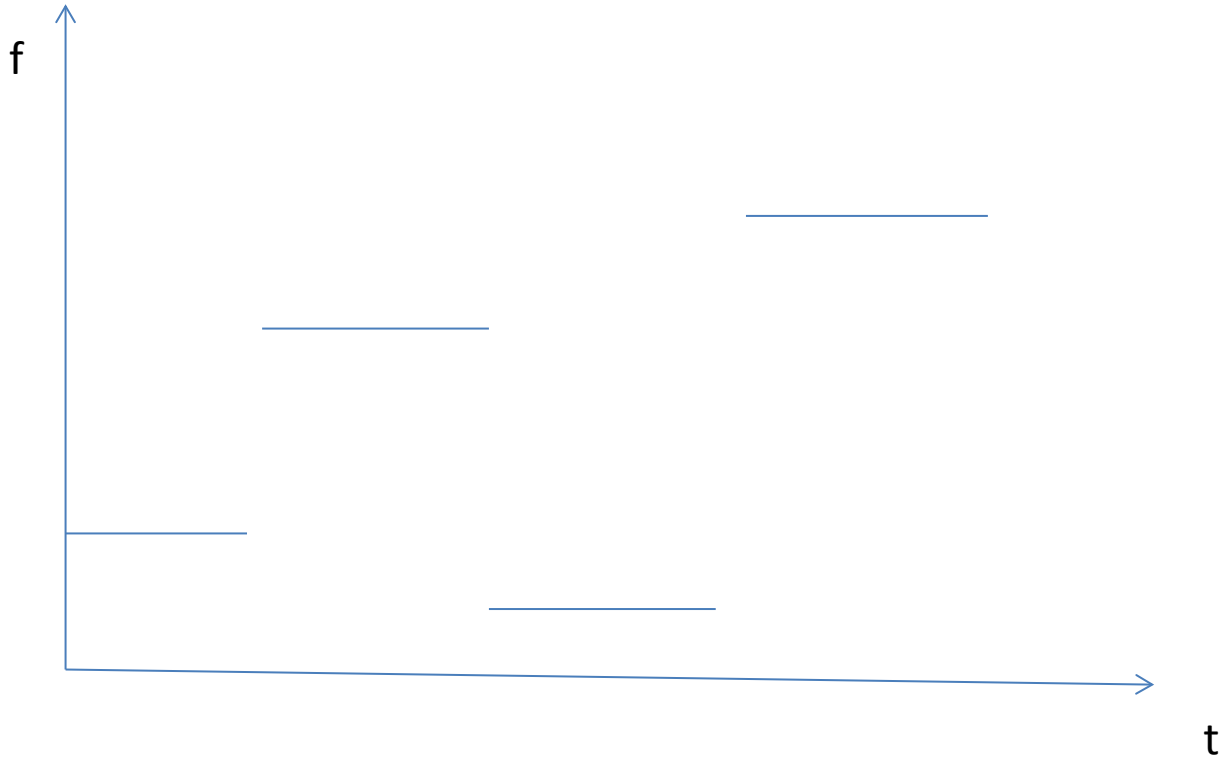

# IDGT: Synthesis

## GFDM: transmitter

Form transmitted signal  $s(k)$

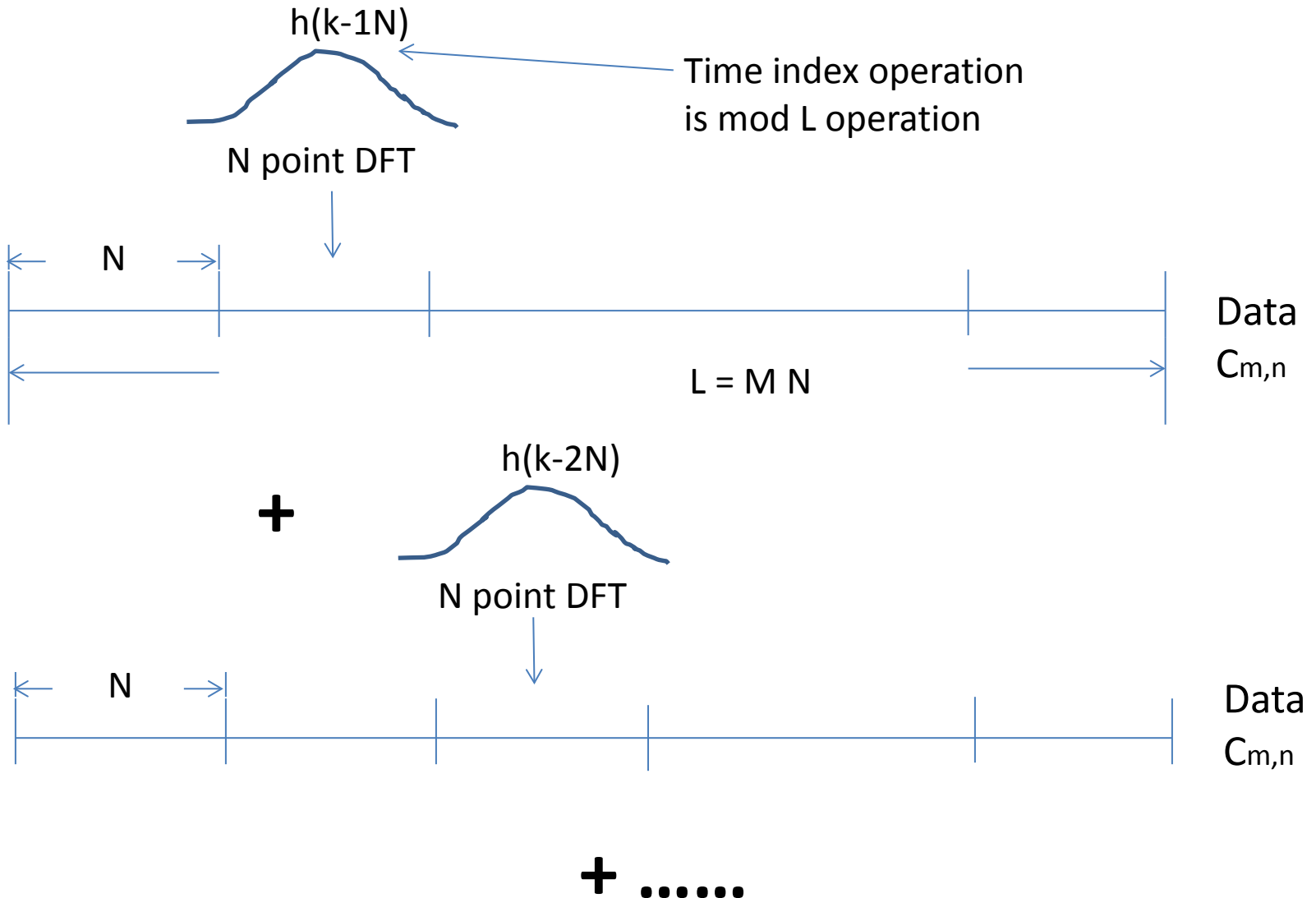

## Discrete Gabor Transform (DGT): A Review

- $s[n]$ : an input signal.
- $h[n]$  ( $\gamma[n]$ ): synthesis (analysis) window function.
- $s[n], h[n], \gamma[n]$  are periodic with period  $L$ .
- **DGT:**

$$C_{m,n} = \sum_{k=0}^{L-1} s[k] \gamma_{m,n}^*[k],$$

where  $W_L = \exp(j2\pi/L)$ ,

$$h_{m,n}[k] = h[k - m\Delta M] W_L^{n\Delta N k},$$

and

$$\gamma_{m,n}[k] = \gamma[k - m\Delta M] W_L^{n\Delta N k}.$$

# Discrete Gabor Transform (DGT): A Review

- IDGT:

$$s[k] = \sum_{m=0}^{M-1} \sum_{n=0}^{N-1} C_{m,n} h_{m,n}[k].$$

- The DGT and IDGT hold under the Wexler-Raz Identity:

$$\sum_{k=0}^{L-1} h[k + mN] W_L^{-nMk} \gamma^*[k] = \delta[m] \delta[n],$$

where  $0 \leq m \leq \Delta N - 1, 0 \leq n \leq \Delta M - 1$ .

- $\Delta M$  ( $\Delta N$ ): Time (frequency) sampling interval length.
- $M$  ( $N$ ): Number of points of the time (frequency) sampling.
- Oversampling Case:  $\Delta M \Delta N < L$ .

A time domain signal of length L is converted to a joint time and frequency domain signal of MN samples

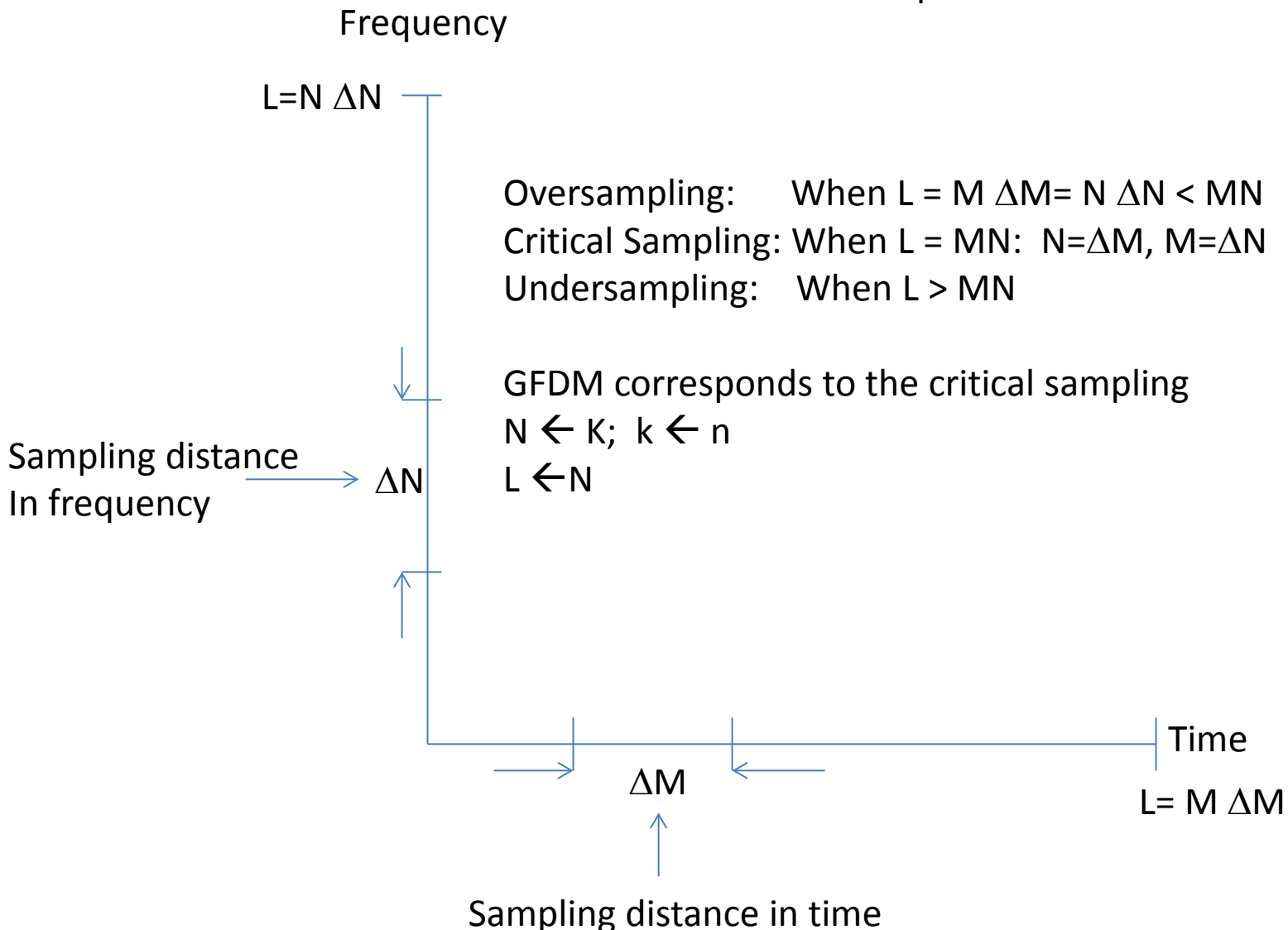
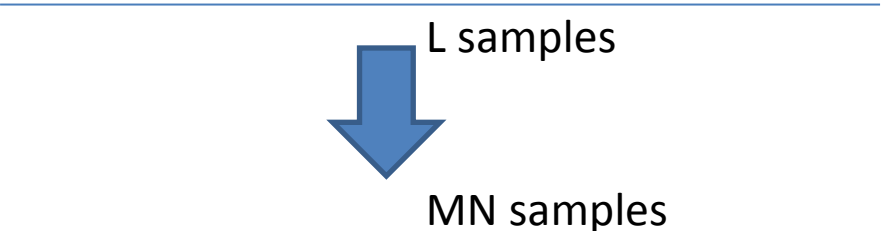

# Two Pulses

(a)

Name	Frequency response
RC	$G_{RC}[f] = \frac{1}{2} \left[ 1 - \cos(\pi \operatorname{lin}_\alpha(\frac{f}{M})) \right]$
Root RC	$G_{RRC}[f] = \sqrt{G_{RC}[f]}$
1st Xia [31]	$G_{Xia}[f] = \frac{1}{2} \left[ 1 - e^{-j\pi \operatorname{lin}_\alpha(\frac{f}{M}) \operatorname{sign}(f)} \right]$
4th Xia [31]	$G_{Xia4}[f] = \frac{1}{2} \left[ 1 - e^{-j\pi p_4(\operatorname{lin}_\alpha(\frac{f}{M})) \operatorname{sign}(f)} \right]$

(b)

Window	Time domain
Rect	$w_{\text{Rect}}[n] = 1$
Ramp	$w_R[n] = \operatorname{lin}_{\frac{N_W}{KM}} \left[ \frac{KM+N_W}{2KM} \left( \frac{2n}{KM+N_{CP}} - 1 \right) \right]$
RC	$w_{RC}[n] = \frac{1}{2} [1 - \cos(\pi w_R[n])]$
4th RC	$w_{RC4}[n] = \frac{1}{2} [1 - \cos(\pi p_4(w_R[n]))]$

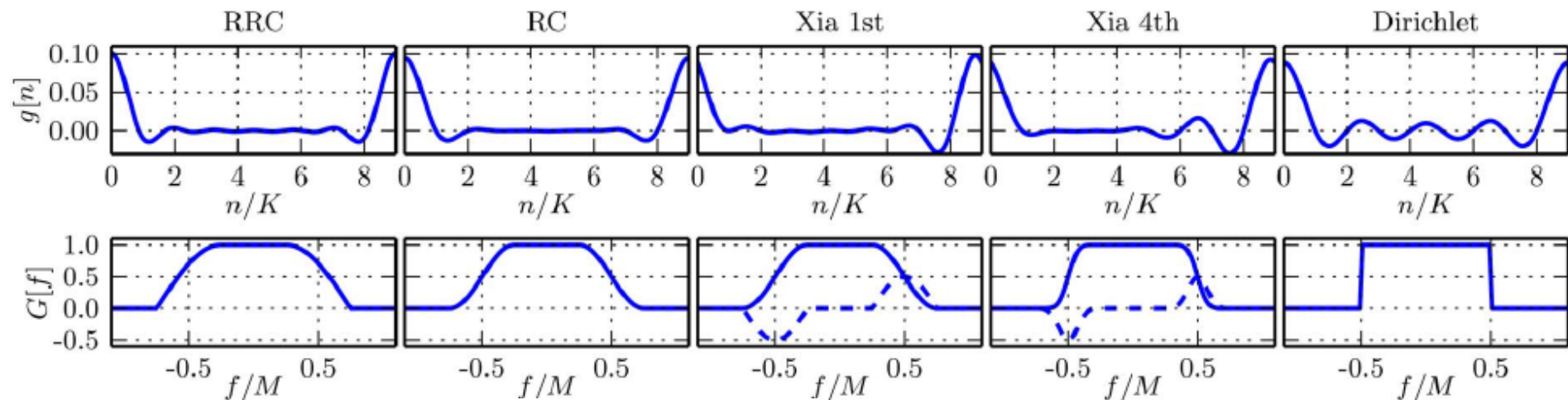

$$h_{Xia}(t) = \begin{cases} \frac{\pi}{2} \operatorname{sinc}\left(\frac{t}{T}\right) & t = -\frac{T}{2\alpha} \\ \operatorname{sinc}\left(\frac{t}{T}\right) \frac{\cos(\frac{\pi t}{2T})}{\frac{\pi t}{2T} + 1} & \text{otherwise} \end{cases}$$

It is ISI free (Nyquist pulse) with or without matched filtering

# OFDM is a special case of GFDM

- When  $h(k)$  is rectangular pulse of support  $[0, N-1]$ , GFDM is the same as OFDM



# OQAM-OFDM (similar to GFDM), transmitter

Form transmitted signal  $s(k)$

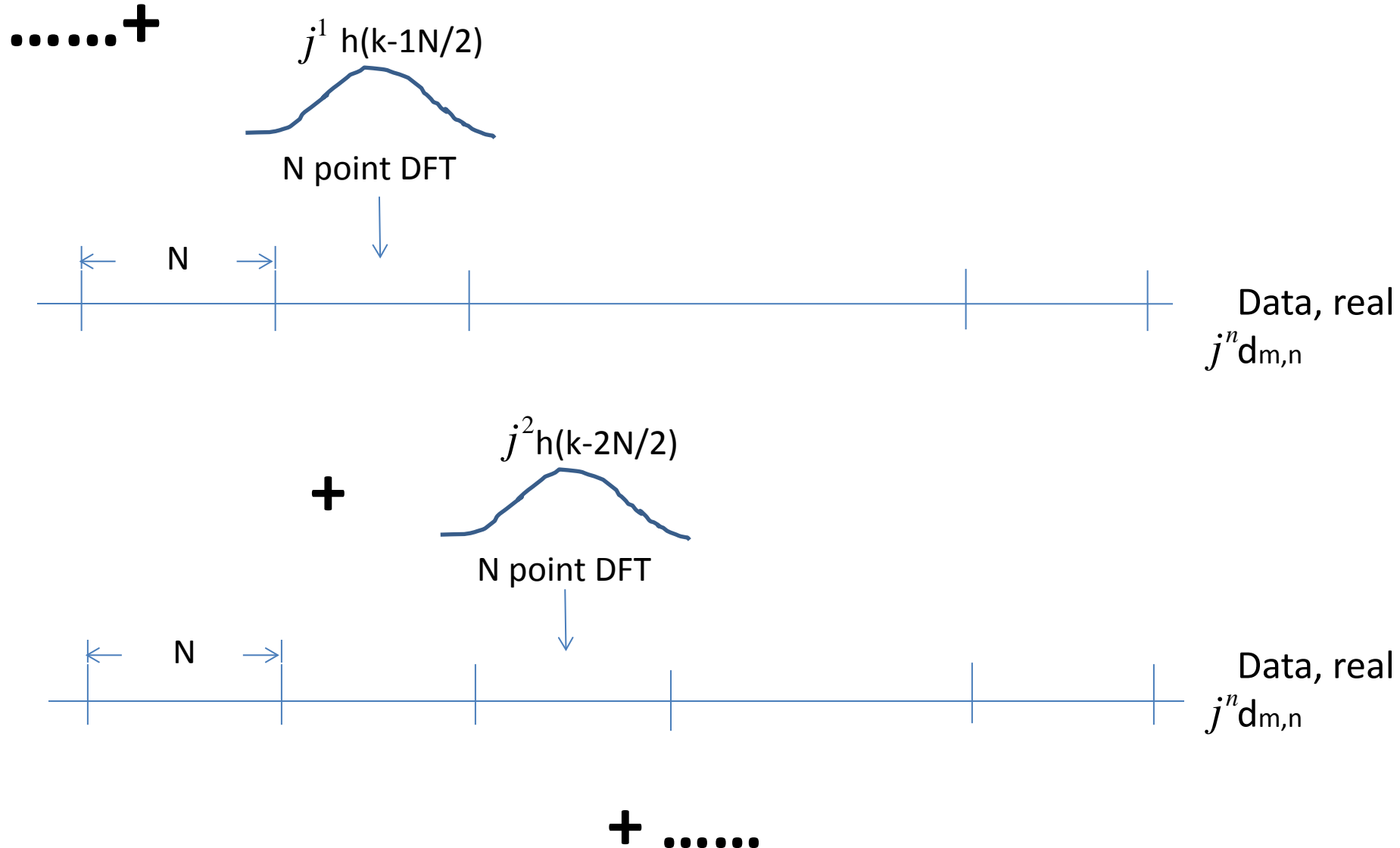

# OQAM-OFDM, Receiver, compared to GFDM

- The pulse/filter  $\gamma(k)$  used at the receiver **is the same as** the pulse/filter  $h(k)$  used at the transmitter
- The overall filter/process is unitary/orthogonal
- While in GFDM, the overall filter/process is not unitary/orthogonal but *bi-orthogonal*
  - It leads to the simpler structure/notation
  - Noise may be enhanced due to the non-orthogonality

# Transmultiplexer/FBMC

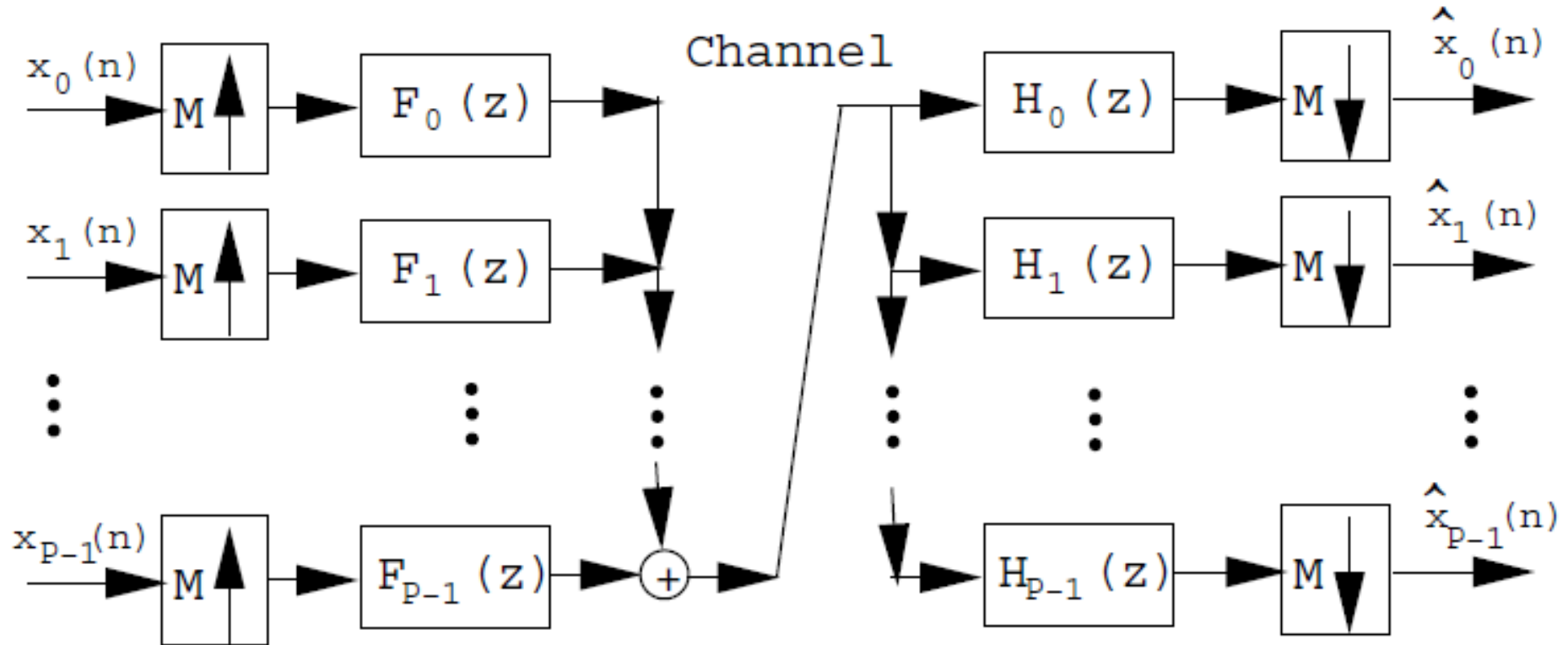

# How To Design These Filters?

- It is too expensive in terms of spectrum if all of them are designed as non-overlapping bandpass filters to separate users (FDMA)

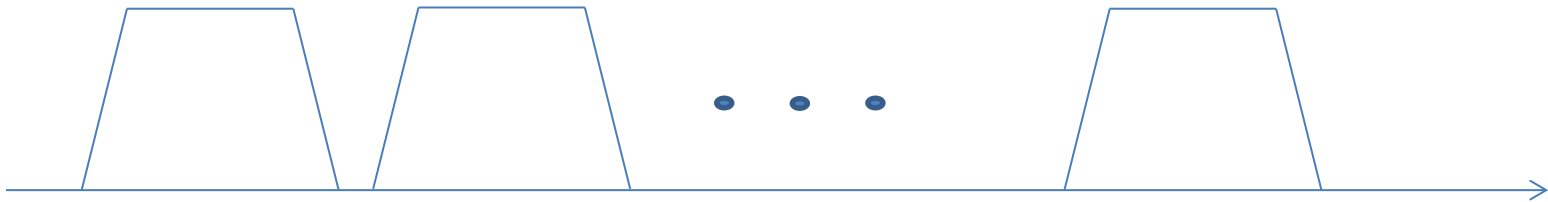

- For better spectrum efficiency, the question is: can these subbands overlap each other but their signals still be separated/recovered??



- **Why can we do so???**
  - Thank Intel/TI for fast chip speed to make digital signal processing fast enough so that digital communications possible
  - **Although their analog spectrums are overlapped, their digital samples can be separated/recovered**

# A Multirate Bank by Reversing a Transmultiplexer

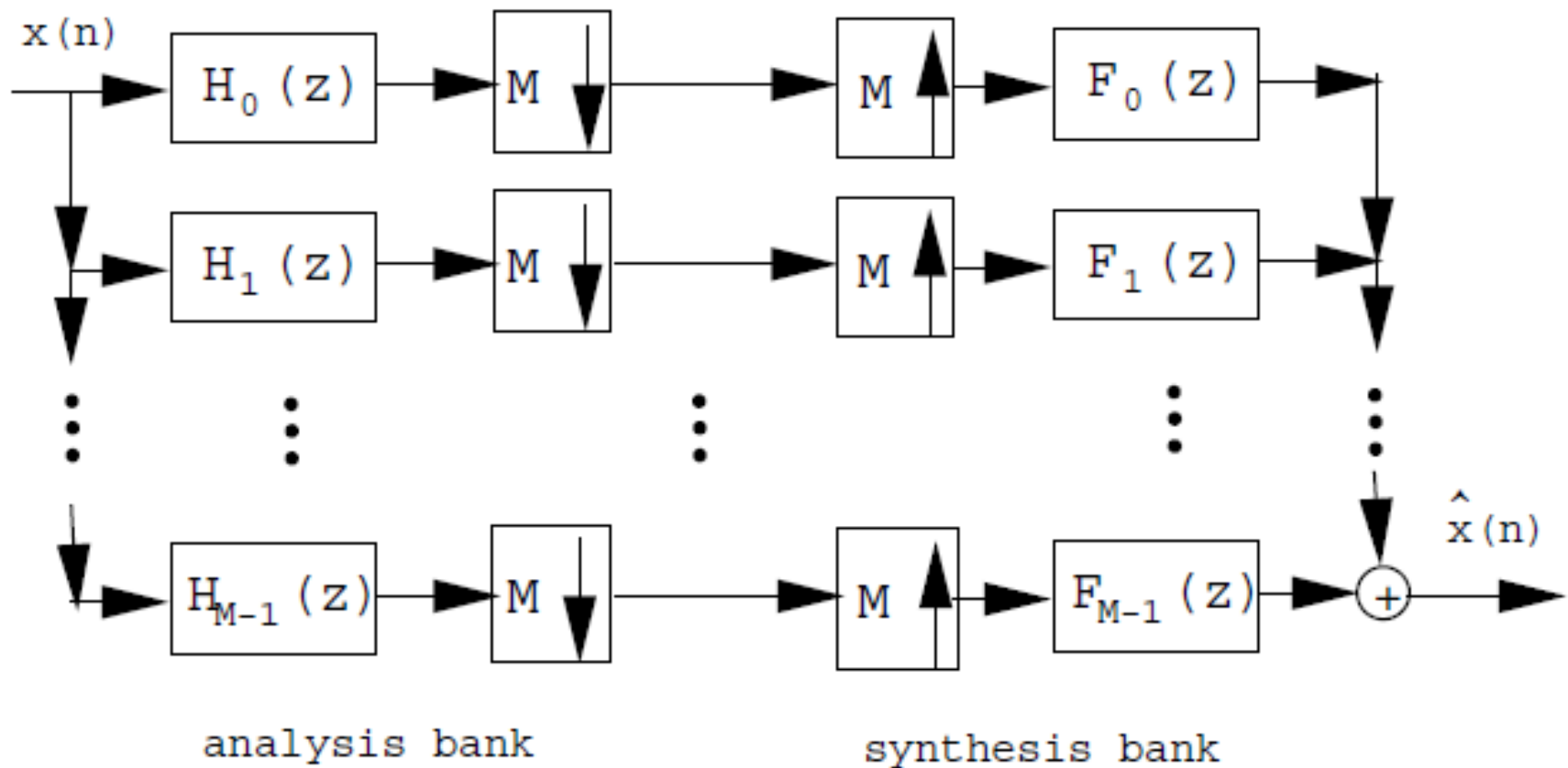

# Question

- For a given set of FIR analysis (or synthesis) filters/banks,  $H_0(z), \dots, H_{M-1}(z)$  are there FIR synthesis (or analysis) bank  $F_0(z), \dots, F_{M-1}(z)$  such that  $\hat{x}(n) = x(n)$ ? Perfect reconstruction (PR)
- When  $M=1$ , it is impossible unless it is a constant or a pure delay.
- When  $M>1$ , it is possible. Systematic studies have been done in multirate filterbank theory by P. P. Vaidyanathan et al.
  - When  $M=2$ , it corresponds to wavelets with compact support

# The Simplest Multirate Filterbank: DFT Filterbank (OFDM)

Let  $P(z) = \sum_{n=0}^{L-1} p(n)z^{-n}$ , be a prototype filter

Let  $H_m(z) = P(zW_M^m) = \sum_{n=0}^{L-1} p(n)W_M^{-mn}z^{-n}$ ,  $0 \leq m \leq M-1$  be evenly shifted filters of the prototype filter  $P(z)$  in the frequency domain

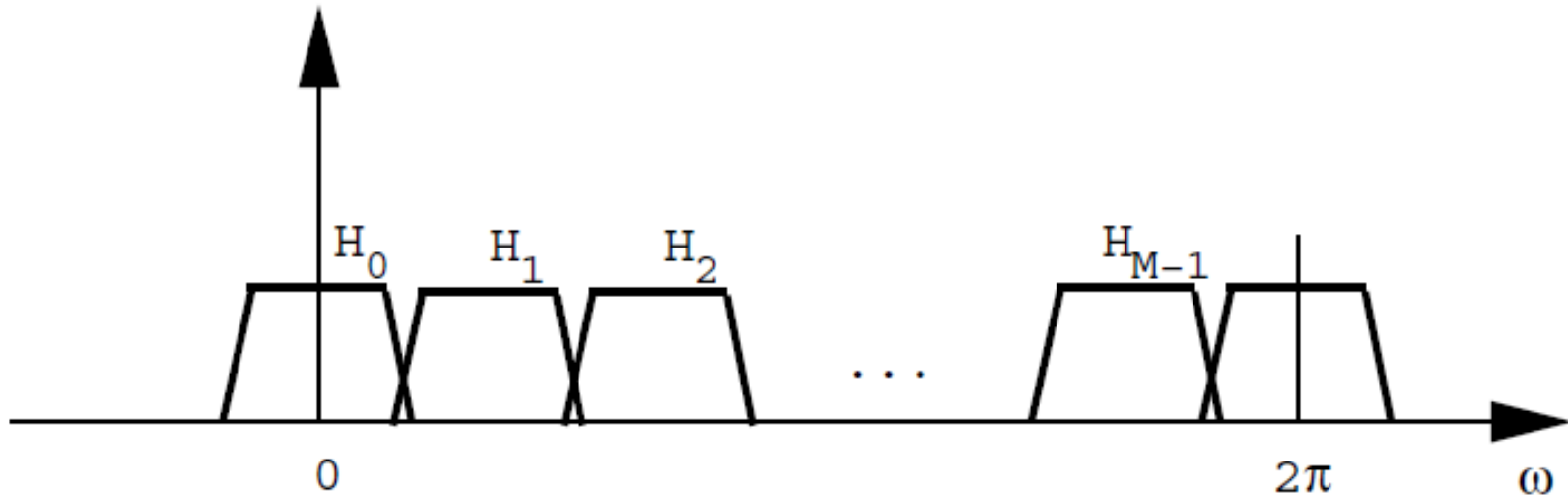

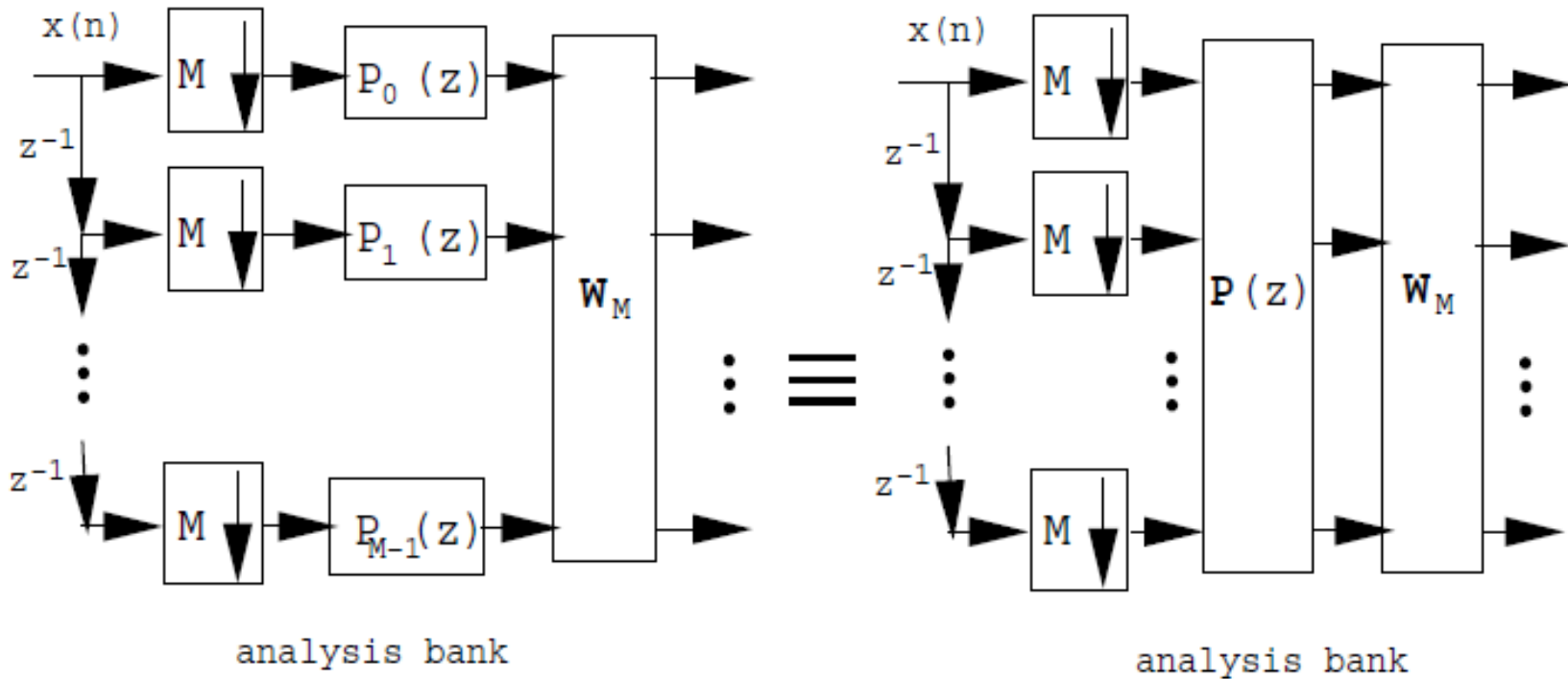

Figure 21: DFT analysis bank.

**Unfortunately, in this case, it has FIR PR if and only if  $P(z)$  is rectangular pulse**



# OFDM (before adding cyclic prefix (CP))

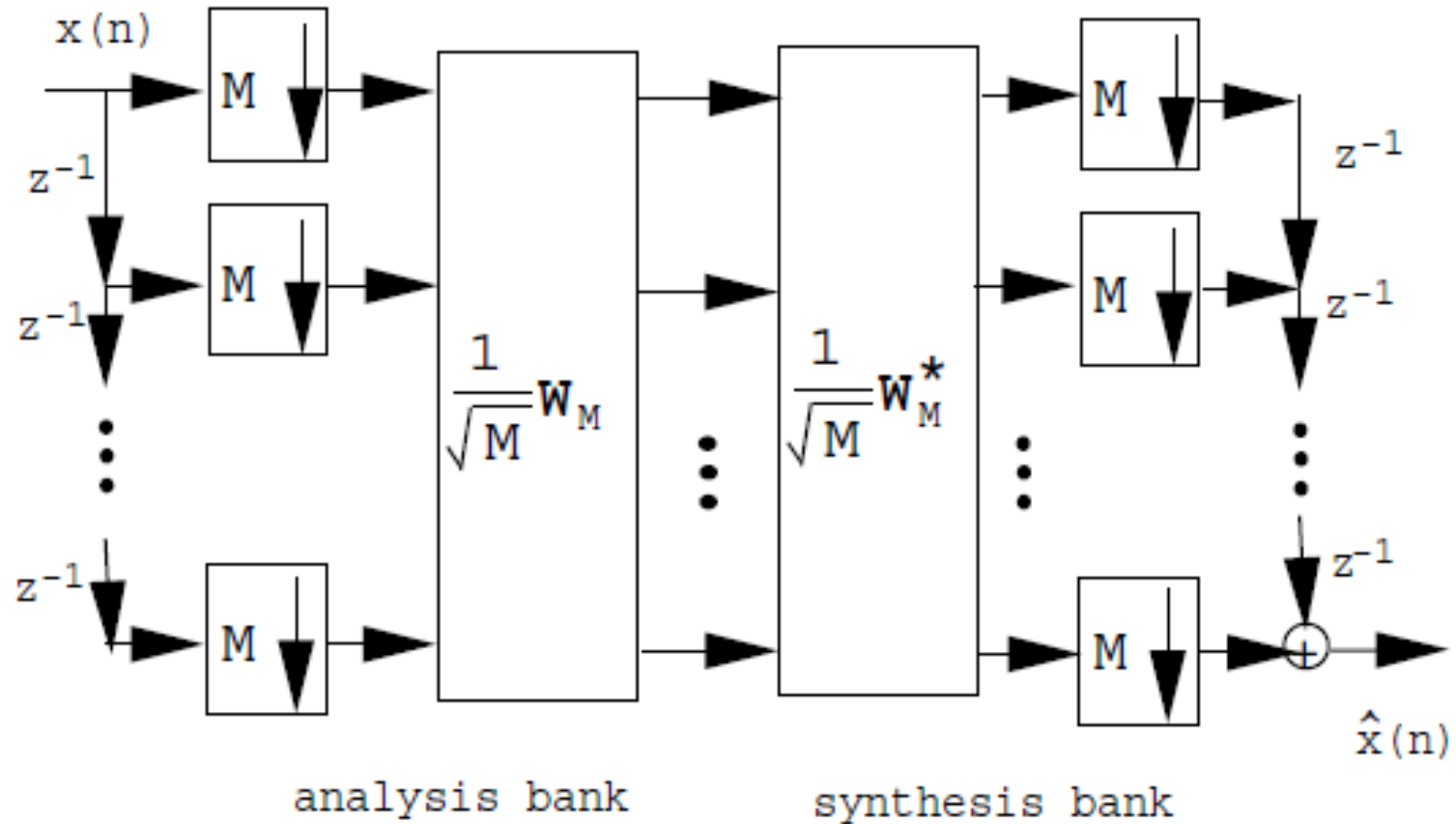

Figure 22: DFT (analysis bank) and IDFT (synthesis bank).

# Two Ways to Get Around of It

- DGT/IDGT: Make the pulse periodic by mod  $L$  on the time index but still bi-orthogonal not orthogonal (paraunitary)
- Split input signal to real and imaginary parts using a single pulse: It is equivalent to cosine modulated filters (OQAM-OFDM). It can be orthogonal (paraunitary).

# Narrowband vs. Wideband

- Transmultiplexer is a way of multiple access (MAC) and was the only way in the past of analog systems as FDMA
- If the whole band is narrow enough, such as 2G and 3G, pulsed TDMA and/or CDMA works fine, no transmultiplexer (OFDM, GFDM, or OQAM-OFDM, FBMC) is needed
- If the whole channel band is wide, there will be severe inter-symbol interference (ISI).
  - Any spectrum efficient system (such as spectrum overlapped transmultiplexer) that converts a wideband channel to narrowband channels is interesting, since it converts a severe ISI channel to less-severe ISI channels
  - The question becomes: is it better than OFDM??

# Pros and Cons of GFDM

- Pros: better spectrum than OFDM when the pulse  $h(k)$  is a good pulse
  - Good for narrow band (flat fading) channels
  - But, due to the mod  $N$  operation for the time index of  $h(k)$  for restricting the block based process of length  $N$ , its spectrum is not as good as OQAM-OFDM (or FBMC)
  - Its block length can be smaller than that of OQAM-OFDM and also is more convenient than OQAM-OFDM
- Cons: For a broadband channel, its receiver will be too complicated.
  - When CP is added to simplify the receiver, its spectrum will then be not good anymore, similar to OQAM-OFDM or FBMC.
  - Since it is only bi-orthogonal, the receiver may enhance noise
- I do not see its potential to 5G unless the signal bandwidth is fixed.

# Sparse Code Multiple Access (SCMA)

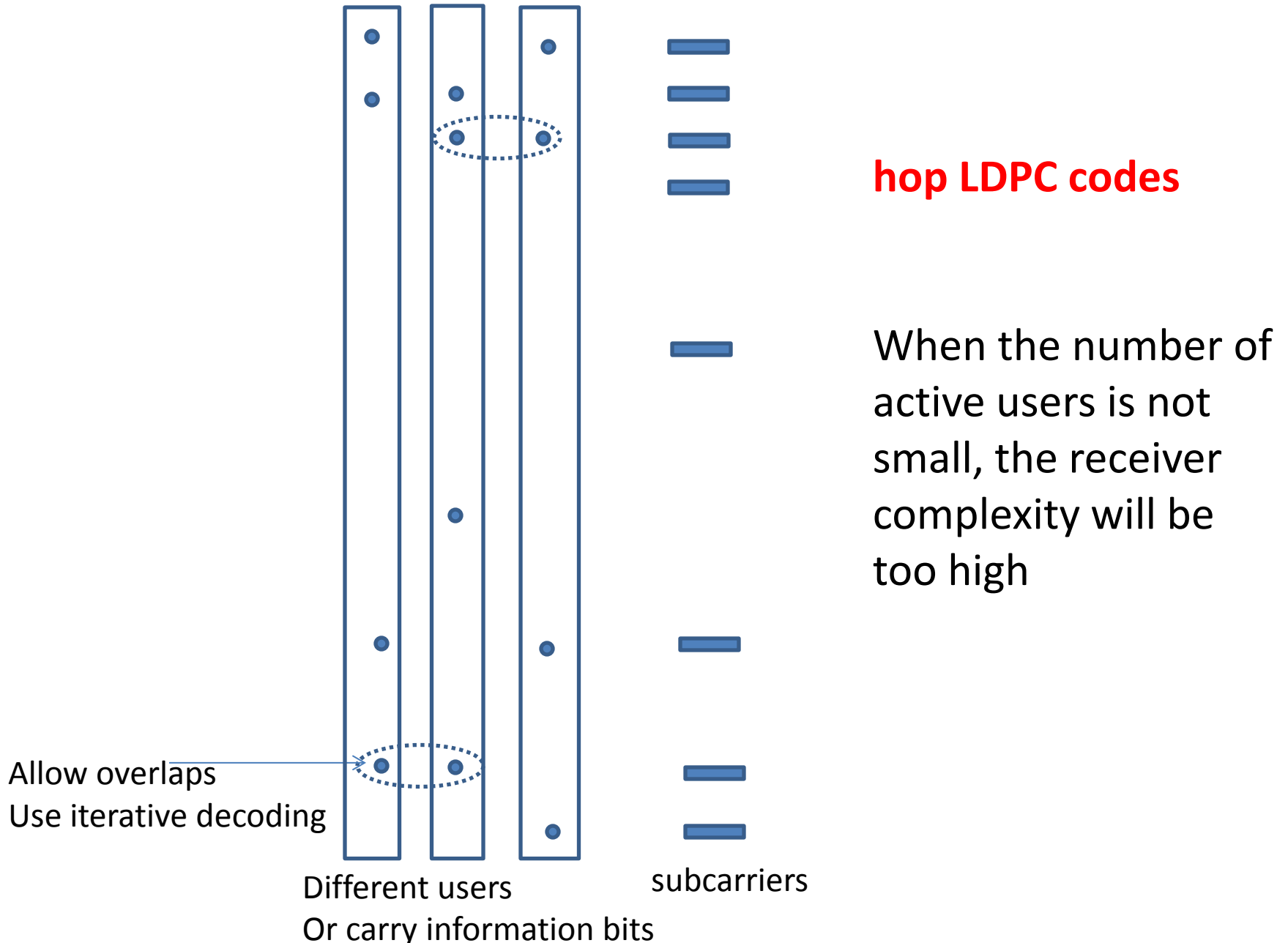

# Massive MIMO

- Pilot contamination problem
- Fast demodulation and decoding with spatial diversity

---

# Vector OFDM for Single Transmit Antenna

- Not Cisco's MIMO-OFDM



# Basic Idea for Vector OFDM Single Transmit Antenna System

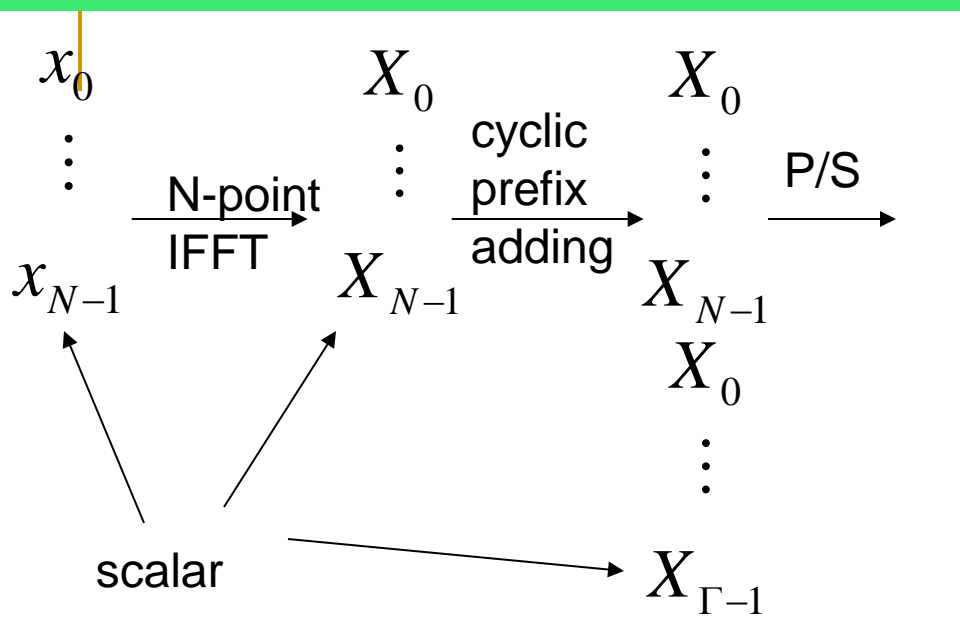

**OFDM**, when data rate overhead  $\Gamma \geq L$

Receiver:

$$Y_k = H_k x_k + W_k$$

$N$  scalar channels/equations

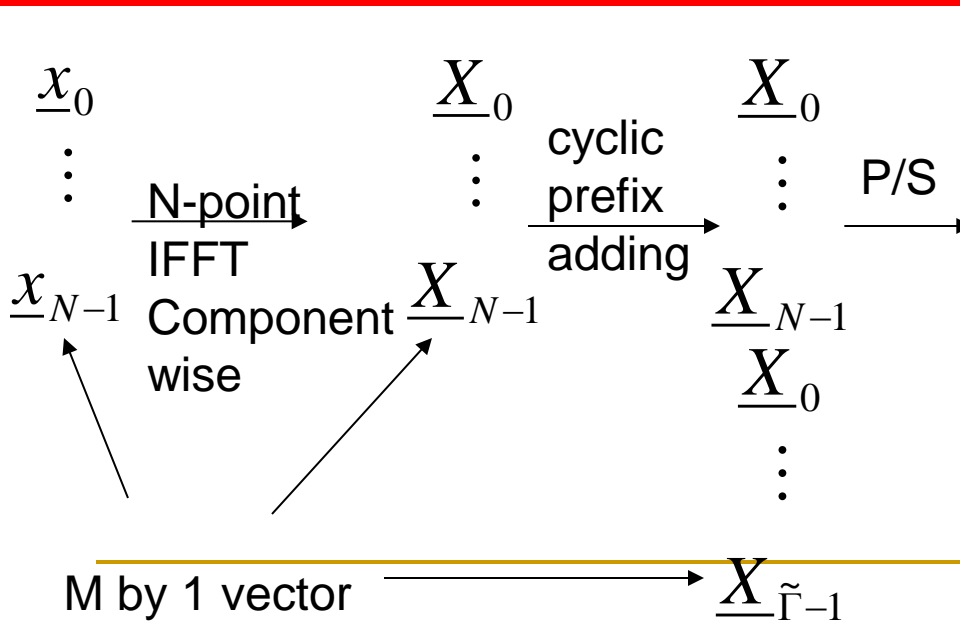

**VOFDM**, when data rate overhead  $\tilde{\Gamma} \geq \tilde{L} \approx \frac{L}{M}$

Receiver:

$$\underline{Y}_k = \underline{H}_k \underline{x}_k + \underline{W}_k$$

$NM$  by 1 vector channels/equations



# VOFDM: Vectorized Channel

- The ISI channel  $H(z)$  is converted into  $N$  vector channels

$$\underline{Y}_k = \underline{H}_k \underline{x}_k + \underline{W}_k, \quad k=0, 1, \dots, N-1$$

where  $\underline{H}_k$  is the  $M$  by  $M$  blocked version of the original frequency responses of the ISI  $H(z)$ :

$$\underline{H}_k = \underline{H}(e^{j2\pi k/N}), \quad \underline{H}(z) = \begin{bmatrix} H_0(z) & z^{-1}H_{M-1}(z) & \cdots & z^{-1}H_1(z) \\ H_1(z) & H_0(z) & \cdots & z^{-1}H_2(z) \\ \vdots & \vdots & \vdots & \vdots \\ H_{M-1}(z) & H_{M-2}(z) & \cdots & H_0(z) \end{bmatrix}$$

$$H_m(z) = \sum_{l=0}^{\tilde{L}'} h(Ml + m) z^{-l}, \quad 0 \leq m \leq M - 1.$$

$m$ th polyphase component of  $H(z)$

$$\tilde{L}' = \left\lfloor \frac{L}{M} \right\rfloor$$

# Vectorized Channel Example

If  $H(z) = 1 + 0.9z^{-1} - 0.8z^{-2} + 0.6z^{-3} + 0.5z^{-4} - 0.4z^{-5}$ , vector size  $M=2$ ,

then, its polyphase components are

$$H_0(z) = 1 - 0.8z^{-1} + 0.5z^{-2}, \quad H_1(z) = 0.9 + 0.6z^{-1} - 0.4z^{-2}$$

and the vector channel coefficient matrices are

$$\underline{H}(z) = \begin{bmatrix} H_0(z) & z^{-1}H_1(z) \\ H_1(z) & H_0(z) \end{bmatrix}$$

$$L = 5$$

$$\tilde{L} = \left\lceil \frac{L}{M} \right\rceil = \left\lceil \frac{5}{2} \right\rceil = 3$$

$$= \begin{bmatrix} 1 & 0 \\ 0.9 & 1 \end{bmatrix} + \begin{bmatrix} -0.8 & 0.9 \\ 0.6 & -0.8 \end{bmatrix} z^{-1} + \begin{bmatrix} 0.5 & 0.6 \\ -0.4 & 0.5 \end{bmatrix} z^{-2} + \begin{bmatrix} 0 & -0.4 \\ 0 & 0 \end{bmatrix} z^{-3}$$

# VOFDM, OFDM, SC-FDE

- When  $M=1$ , VOFDM=OFDM
- When  $M=N$  and the FFT size is 1, VOFDM=SC-FDE:
  - at the transmitter, no IFFT is implemented (so the PAPR is not changed) but just CP of the information symbols is inserted; low PAPR
  - at the receiver, both FFT and IFFT, and frequency domain equalizer are implemented
- VOFDM is a bridge between OFDM and SC-FDE
  - Its ML receiver complexity is also in the middle

Time domain single carrier  
vs. equalization

Maximum # symbols in ISI



VOFDM

No, or 2, or 3, ...,  
or Maximum #  
(**you choose**)  
symbols in ISI



Frequency domain  
OFDM

No ISI



Single antenna VOFDM is in the middle  
between single carrier and OFDM in terms of  
dealing with ISI

# VOFDM: Advantages

- Cyclic prefix data rate overhead reduction when the FFT/IFFT size is fixed
  - For OFDM, it is  $\frac{L}{N}$
  - For VOFDM, it is  $\frac{L}{MN}$
- For fixed cyclic data rate overhead, the FFT/IFFT size can be reduced by M times
  - The IFFT size reduction reduces the peak-to-average power ratio (PAPR), which is important in cellular communications.

# Multiple Antenna VOFDM Using Cyclic Delay Diversity (CDD)

- CDD can be used to collect both spatial and multipath diversities in a MIMO-OFDM systems

$$\begin{array}{ccc} \underbrace{h_{11}, h_{12}, \dots, h_{1L}}_{\rightarrow} & & \\ \vdots & \xrightarrow{\text{After CDD}} & \underbrace{h_{11}, \dots, h_{1L}, \dots, h_{n_t1}, \dots, h_{n_tL}}_{\rightarrow} \\ \underbrace{h_{n_t1}, h_{n_t2}, \dots, h_{n_tL}}_{\rightarrow} & \text{It is equivalent to} & \\ & \text{if } N \geq n_t L & \end{array}$$

**When the bandwidth is larger, the number  $L$  of multipaths will be larger too. Then, CDD in this case may not be able to collect full spatial and multipath diversities anymore.**

# Multiple Antenna VOFDM Using Cyclic Delay Diversity (CDD)

- CDD VOFDM can collect both spatial and multipath diversities despite of a large bandwidth

$$\begin{array}{ccc}
 \begin{array}{c}
 H_{11}, H_{12}, \dots, H_{1\frac{L}{M}} \\
 \xrightarrow{\hspace{10em}} \\
 \vdots \\
 H_{n_t1}, H_{n_t2}, \dots, H_{n_t\frac{L}{M}} \\
 \xrightarrow{\hspace{10em}}
 \end{array}
 &
 \begin{array}{c}
 \text{After CDD} \\
 \xrightarrow{\hspace{10em}} \\
 \text{It is equivalent to} \\
 \text{if } N \geq n_t \frac{L}{M}
 \end{array}
 &
 \begin{array}{c}
 H_{11}, \dots, H_{1\frac{L}{M}}, \dots, H_{n_t1}, \dots, H_{n_t\frac{L}{M}} \\
 \xrightarrow{\hspace{10em}}
 \end{array}
 \end{array}$$

**The number of multipaths is equivalently reduced by  $M$  times for VOFDM with a vector size  $M$**

---

# V-OFDM for Broadband Sparse Channels

- Q. Feng and Xia, employing sparse FFT, fast channel estimation and demodulation for V-OFDM have been proposed.
-



# Recall Physical Layer Communications Developments in Recent Decades for Both Wireless and Wired Systems

- It has been always on dealing with ISI

Time domain single carrier  
vs. equalization

Maximum # symbols in ISI



VOFDM

No, or 2, or 3, ...,  
or Maximum #  
(**you choose**)  
symbols in ISI



Frequency domain  
OFDM

No ISI



Is this VOFDM something to think about  
after OFDM?

Or what's next???